



2018
O C A K



Siz hayal edin, biz gerçekteşirelim...

KURUMSAL

*Siz hayal edin,
biz gerçektirelim.*

STROPOL kendi sektöründe, dinamik kadrosu ve profesyonel yaklaşımıyla sektörel alanda ilklerin temsilcisi olmayı hedeflemektedir.

STROPOL ürünleri hafif ve hızlı monte edilebildiği gibi, hem iç hem dış cephe sistemlerinden oluşmaktadır.

Üretimde, dış cephe ve iç cephe ürünlerine ağırlık veren firmamızın önem verdiği unsurların başında kalite anlayışı gelmektedir. Üretim süreci dışında, ARGE departmanı sayesinde de yeni ürün ve ürün geliştirmeye önem verilmektedir. Bütün enerjisini üretmeye endeksleyen STROPOL, doğru, kaliteli ürünleriyle, müşteri istek ve ihtiyaçlarını doğru yorumlayan profesyonel kadrosuyla, üretmeye devam etmektedir.



Ayrıca STROPOL üstlendiği misyon ve idealleri çerçevesinde, ülkemizdeki yüksek enerji israfının azaltılmasına katkı sağlarken, yurt genelindeki bayi ağları sayesinde de bölge çalışanlarına istihdam alanı yaratmaktadır.



İÇ CEPHE

Yüksek dansite EPS ve XPS ürünlerin şekillendirilmesiyle elde edilir.

Özellikler:

- Ürünlerin standart boyu 200 cm. dir
- Beyaz renkli olup B1 sınıfı alev yürütmez malzemedir.
- Montajı kolaydır.
- Uzun ömürlüdür.
- İstenilen renk su bazlı boya ile elde edilebilir.
- Yalıtım sağlar.
- İnsan sağlığı için zararsızdır.
- İstenilen model ve ölçüde üretilebilir.

DESENLİ KARTONPİYER / EPS FIGURED MOLDING



K-DES-01 12.5 x 6.5 cm.

Anatolia



K-DES-02 12.5 x 6.5 cm.

Versace

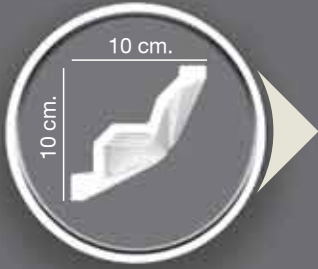

K-DES-03 10 x 10 cm. **Bu model ayrıca 12x12 • 10x10 • 8x8 cm. olarak üretilmektedir.**

Venedik (Efes)

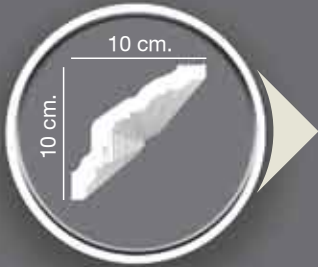

K-DES-04 10 x 10 cm.

Piyano

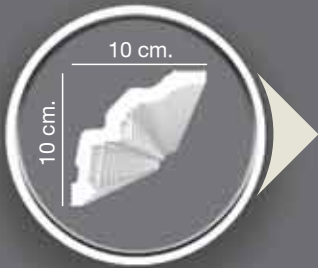

K-DES-05 10 x 10 cm.

Çubuklu Piyano



K-DES-06 12.5 x 6.5 cm.

Vavin



K-DES-07 10.5 x 9.5 cm.

Flora



K-DES-08 8.8 x 6.6 cm.

Floretta



K-DES-09 8 x 8 cm.

Oliva

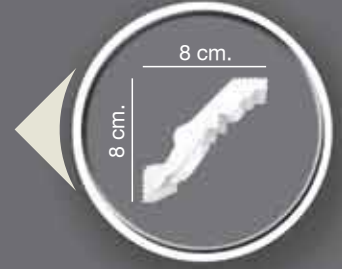

K-DES-10 12.3 x 4.6 cm.

Viona



K-DES-11 10 x 10 cm. **Bu model ayrıca 12x12 • 10x10 • 8x8 cm. olarak üretilmektedir.**

Düz



Siz hayal edin, biz gerçekleştirelim.

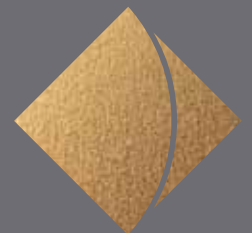

KARTONPIYER / XPS MOLDING

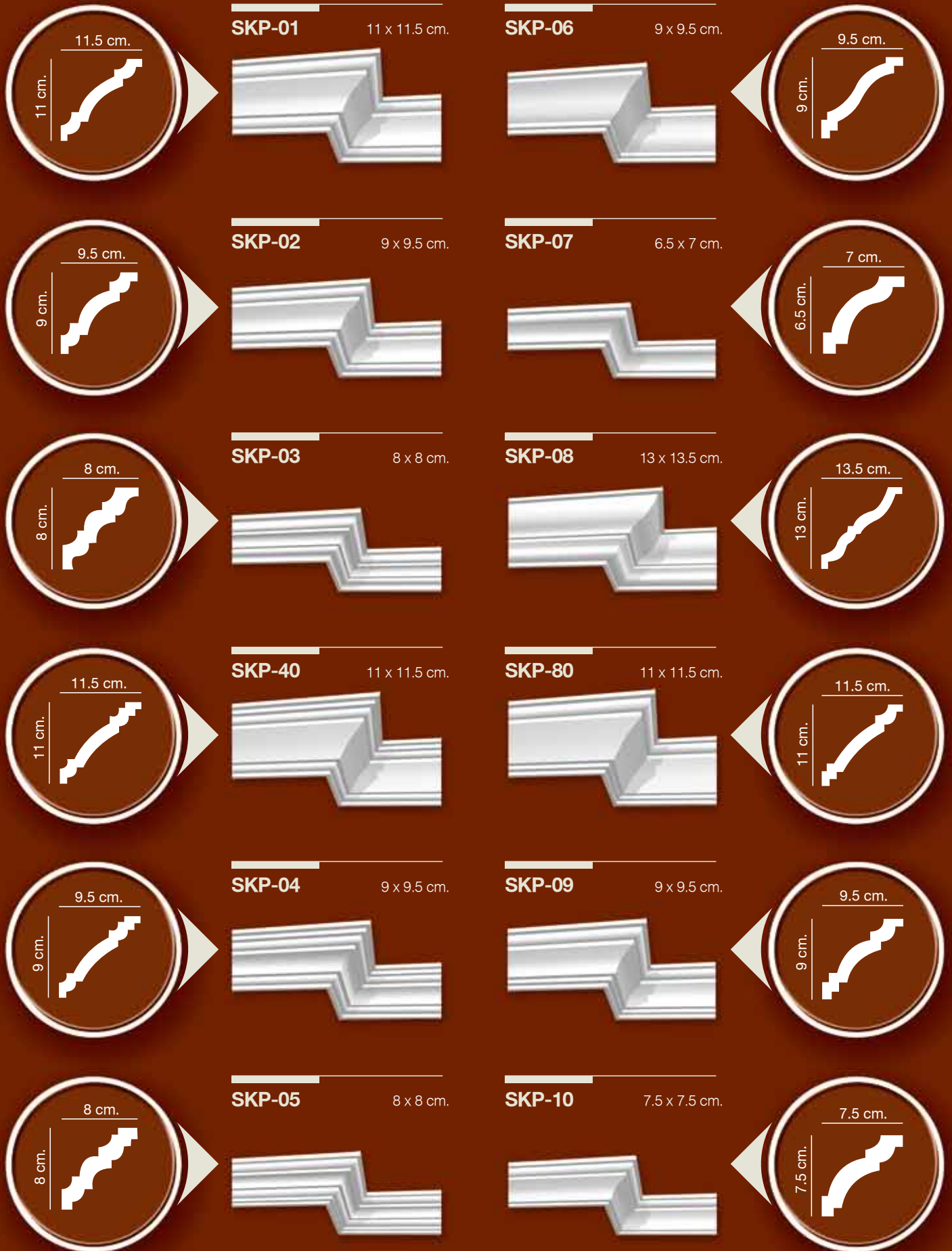



SKP-11 11 x 11.5 cm.



SKP-17 9 x 9 cm.

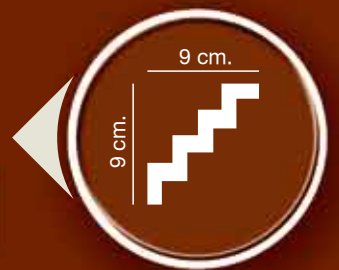

SKP-12 9 x 9 cm.



SKP-18 4 x 4 cm.

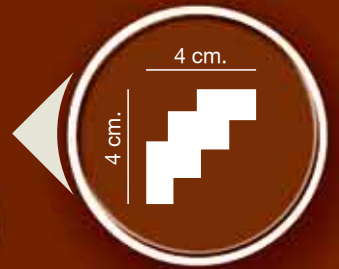

SKP-13 9 x 9.5 cm.



SKP-19 13.5 x 2.2 cm.

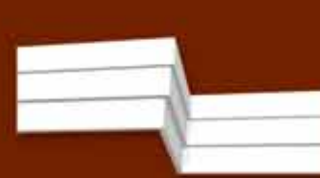

SKP-14 7 x 7 cm.



SKP-20 6.5 x 2 cm.



SKP-15 9 x 9.5 cm.



SKP-21 8 x 8 cm.

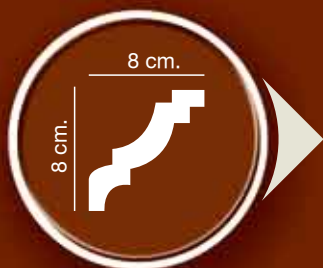
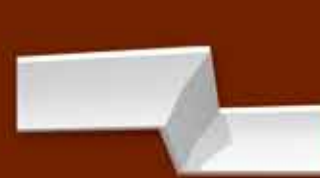

SKP-16 8 x 8 cm.



SKP-22 5 x 5 cm.

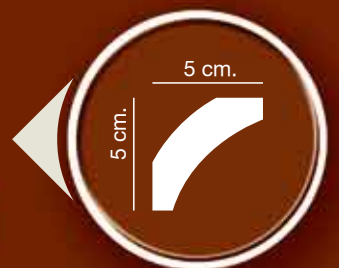

KARTONPİYER / XPS MOLDING

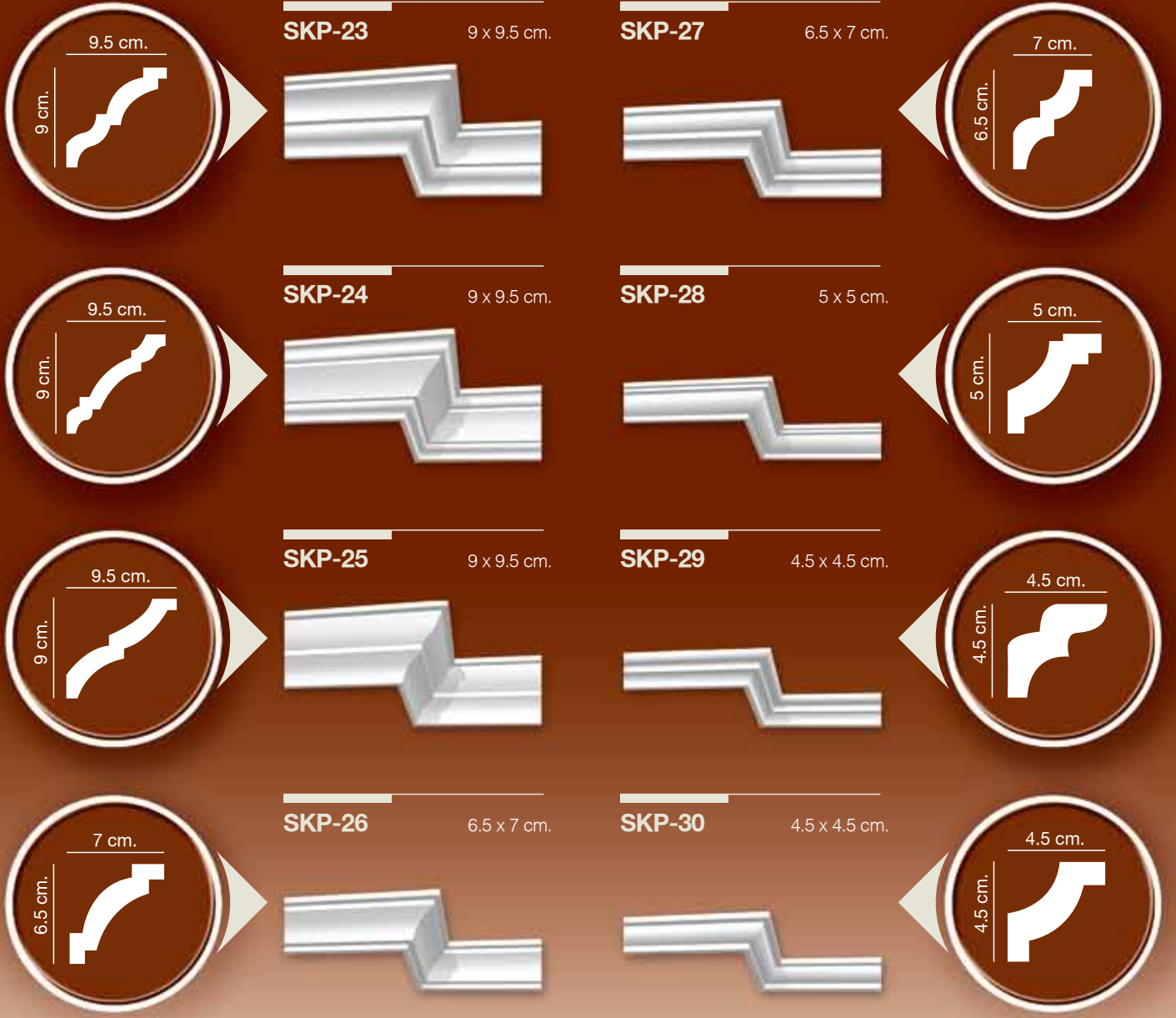

Tavan ve duvarların vazgeçilmez birleşeni.

Tasarımlarını özenle oluşturduğumuz ürün yalpozemizin yanı sıra, isteğiniz doğrultusunda gerçekleştirebildiğimiz özel tasarımlar ile de, siz değerli müşterilerimizin her zaman memnuniyetini ön planda tutmayı hedeflemekteyiz.



DESENLI ÇITA / EPS FIGURED LATH AND CORNER

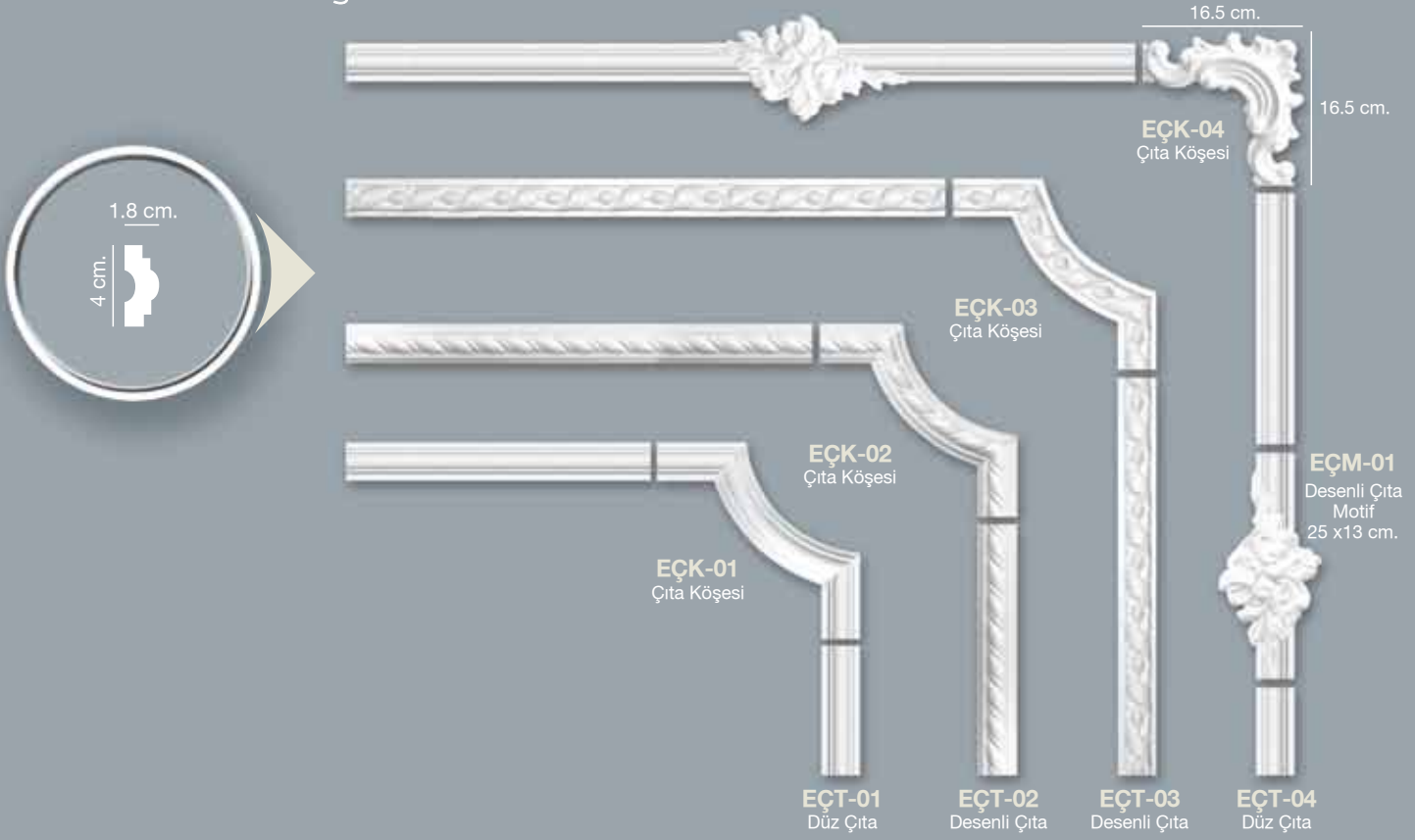

ÇITA / XPS LATH

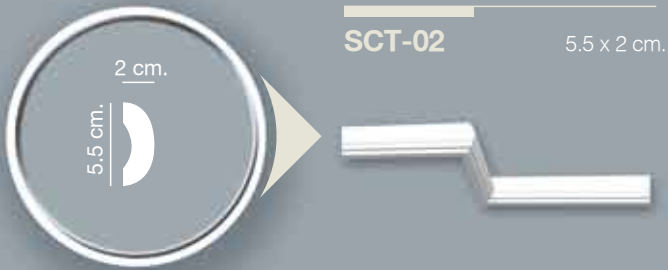
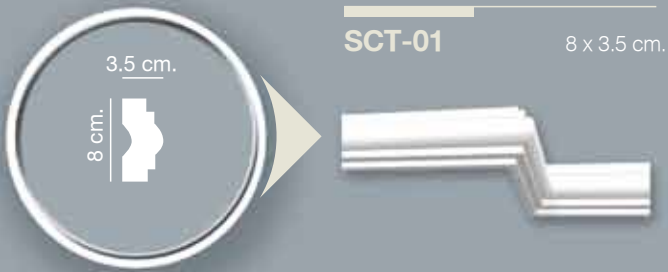

PERDELİK / XPS ADDITIONAL CURTAIN

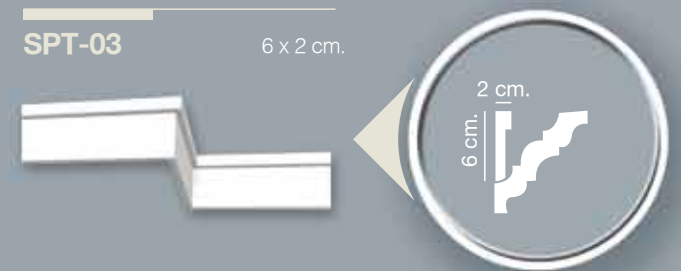
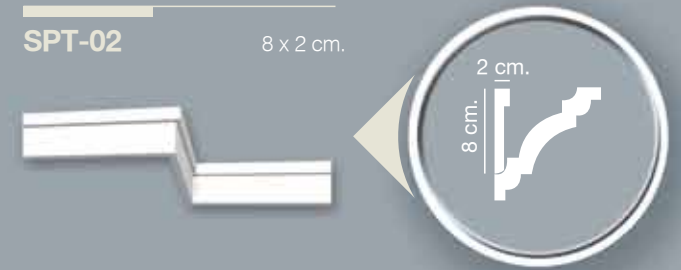
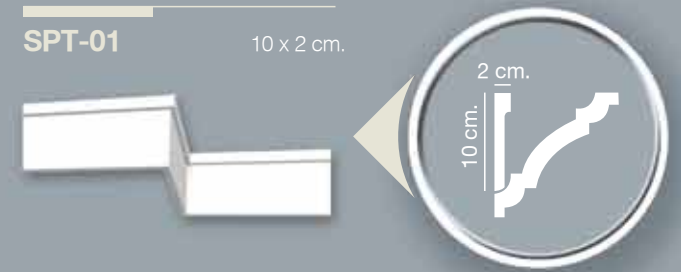

GÖBEK / CEILING ROSE

SGB

Düz

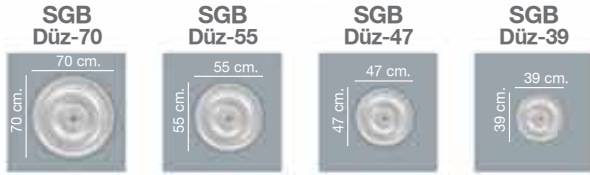

SGB

Versace



SGB

Rapsodi



SGB

Papatya

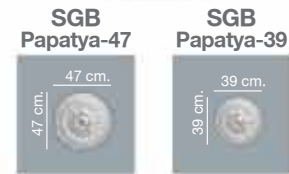

SGB

At Kuyruğu



SGB

Baklava



SGB

Başak

**SGB**
Ba ak-47**SGB**
Ba ak-39**SGB**

Altıgen

**SGB**
Altıgen-45**SGB**

Linda

**SGB**
Linda-70

Tavanların görsel bütünlüğü.

Tavanlardaki görselliği
kreatif boyuta taşıyacak
ürünlerimizden olan tavan göbekleri
ile emeğinizi taçlandırarak
uygulamalara imzanızı atabilirsiniz.

MODEL	ÜRÜN ADI	Çap: cm.
SGB	DÜZ	39
SGB	DÜZ	47
SGB	DÜZ	55
SGB	DÜZ	70
SGB	RAPSODİ	39
SGB	RAPSODİ	47
SGB	RAPSODİ	55
SGB	RAPSODİ	70
SGB	AT KUYRUĞU	39
SGB	AT KUYRUĞU	47
SGB	AT KUYRUĞU	55
SGB	VERSACE	39
SGB	VERSACE	47
SGB	VERSACE	55
SGB	PAPATYA	39
SGB	PAPATYA	47
SGB	BAKLAVA	39
SGB	BAKLAVA	47
SGB	BA AK	39
SGB	BA AK	47
SGB	ALTİGEN	45
SGB	LİNDA	70

TAVAN KAPLAMASI / CEILING PLATE

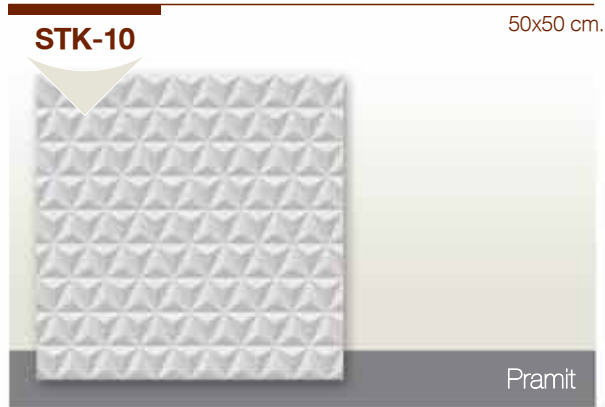
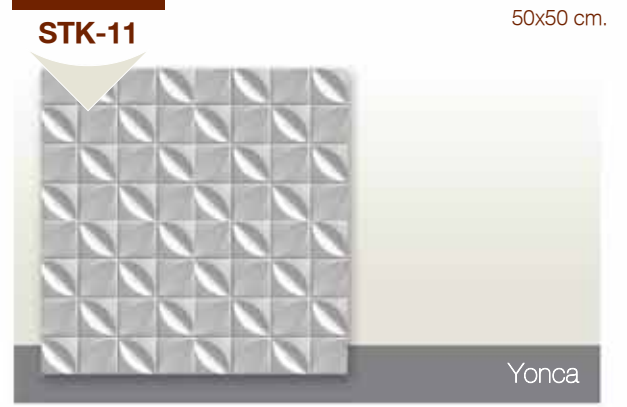
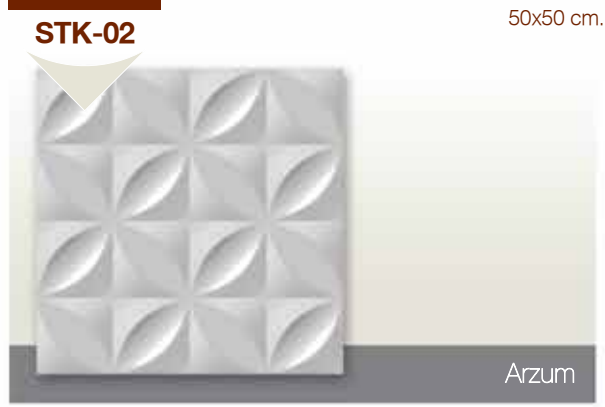

DEKORATİF KIRIŞ / DECORATIVE BEAM

SDK-01



SDK-02



SDK-03



SDK-04



DEKORATİF PAYANDA DECORATIVE BUTTRESS

SDP-01

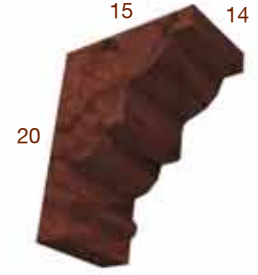

SDP-02



SDP-03



SDP-04



DIŐ CEPHE



Yüksek dansite EPS ve XPS ürünlerin şekillendirilmesiyle elde edilen polistrene, birden çok kimyasal maddenin karıştırılmasıyla oluşan akrilik esaslı reçinenin kaplanmasıyla elde edilir.

Özellikler:

- Ürünlerin standart boyu 200 cm. dir
- Kaplama malzemesinin kalınlığı her yerde aynı olup polistrenden ayrılmaz
- Esnek bir yapısı vardır, esneme yapmaz.
- Statik açıdan hafiftir, binaya yük getirmez.
- İstenilen renk boya ile elde edilebilir.
- Yalıtım sağlar.
- İnsan sağlığı için zararsızdır.
- İstenilen model ve ölçüde üretilebilir
- Uzun ömürlüdür.

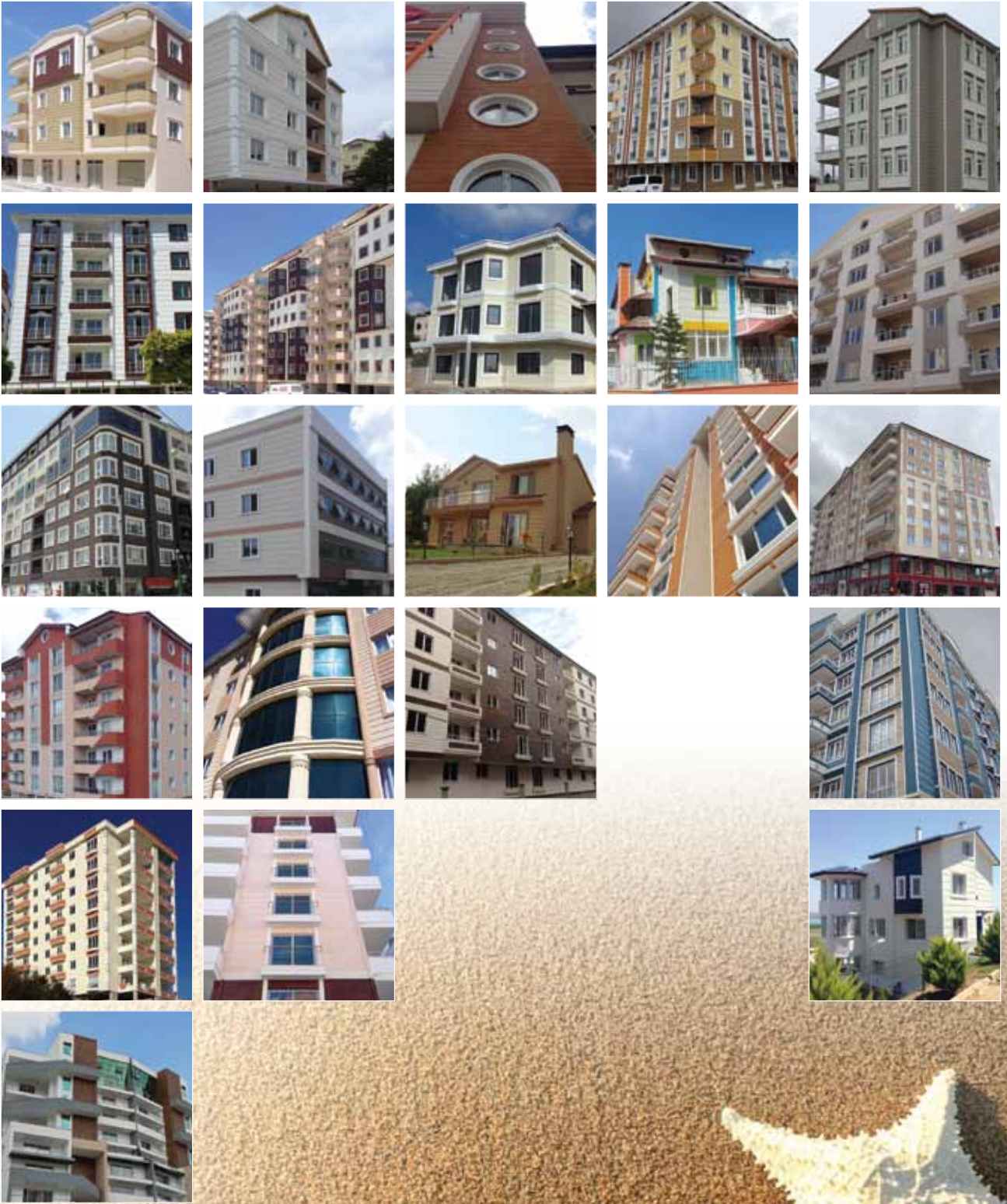

SÖVE / DOOR and WINDOW FRAME

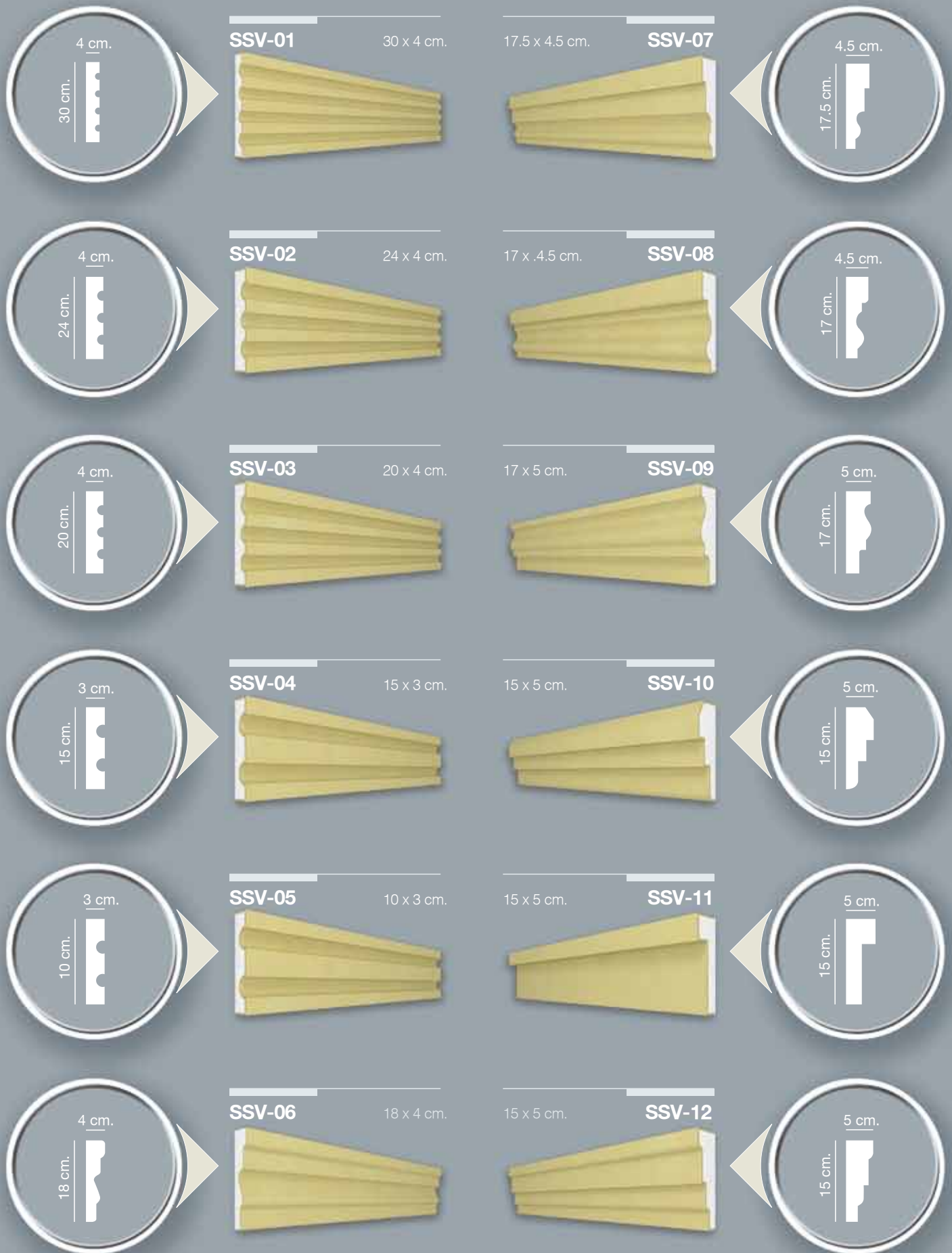



SSV-14

14 x 3.5 cm.



11 x 4.5 cm.

SSV-20



SSV-15

12.5 x 4 cm.



10 x 3.5 cm.

SSV-21



SSV-16

12 x 2 cm.



11.5 x 5.5 cm.

SSV-22



SSV-17

11.5 x 3 cm.



10 x 5 cm.

SSV-23

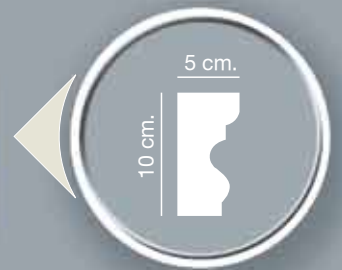

SSV-18

11 x 7 cm.



10 x 3 cm.

SSV-24

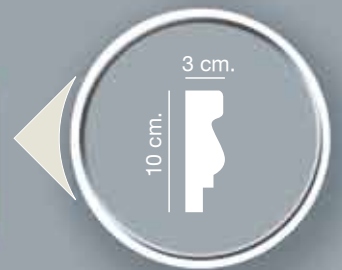

SSV-19

11 x 3.5 cm.

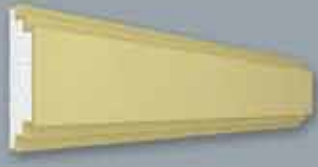

9 x 4 cm.

SSV-25

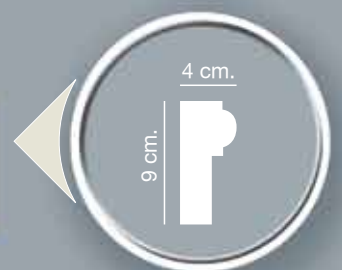

SÖVE / DOOR and WINDOW FRAME

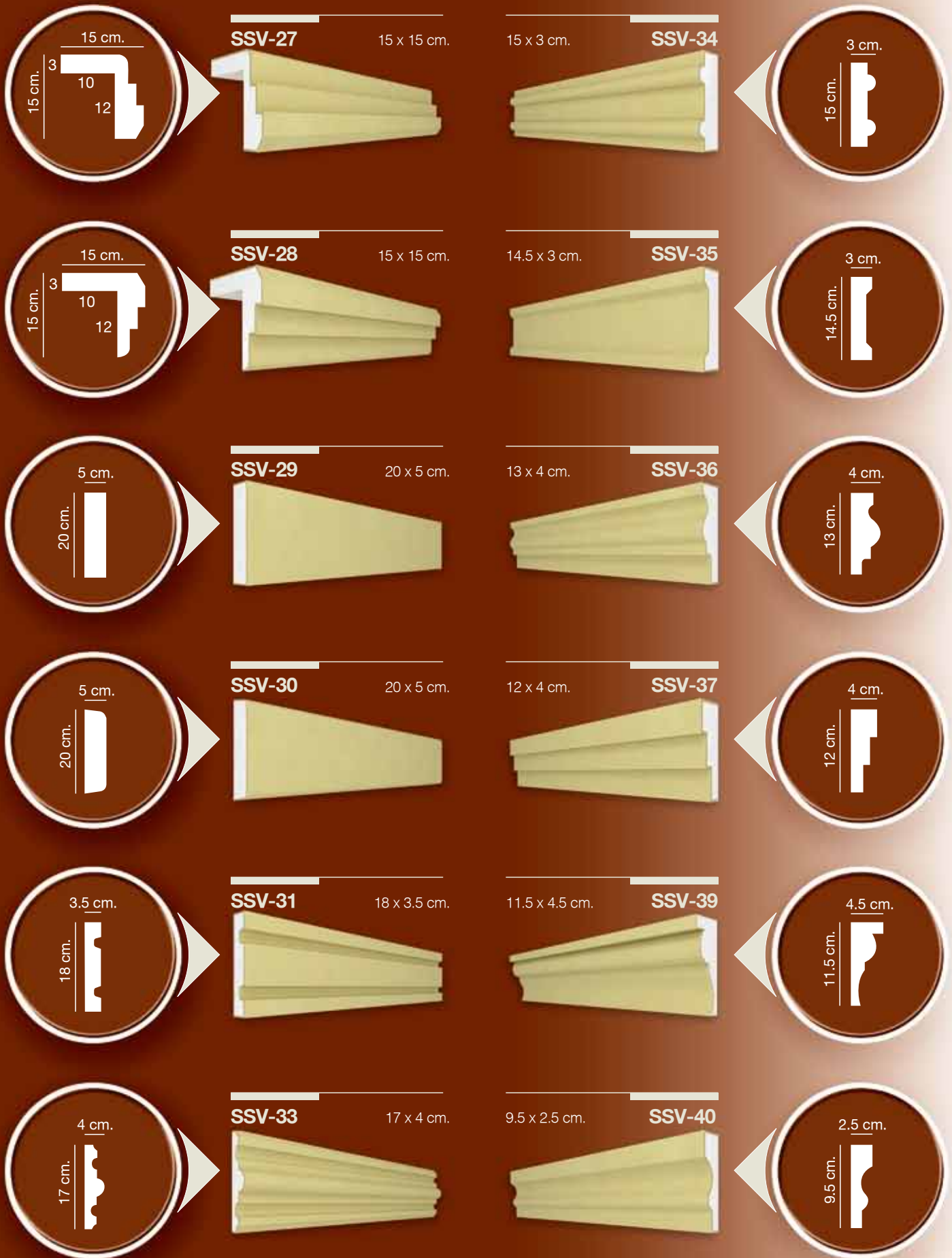



SSV-47

12.5 x 2.5 cm.



SSV-48

15 x 3 cm.



Pencerelerin vazgeçilmez birleşeni.

Ürün çeşitliliği ve kalite üstünlüğü ile yapılarınızın vazgeçilmez birleşeni Söve gurubunda aradığınız her detatayı bulabilirsiniz.

DESENLI SÖVE / FIGURED DOOR and WINDOW FRAME

STS



STS-10 **STS-12** **STS-15** **STS-20**

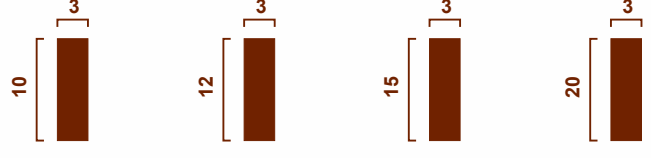

10 x 3 cm. 12 x 3 cm. 15 x 3 cm. 20 x 3 cm.

SAS



SAS-10 **SAS-12** **SAS-15** **SAS-20**

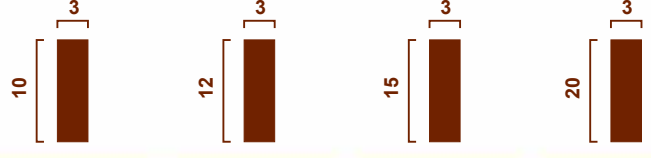

10 x 3 cm. 12 x 3 cm. 15 x 3 cm. 20 x 3 cm.

SCS



SCS-10 **SCS-12** **SCS-15** **SCS-20**

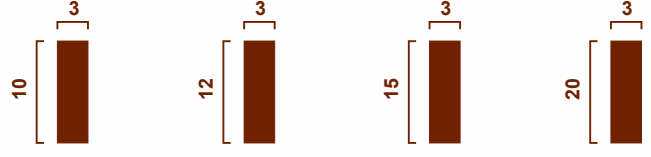

10 x 3 cm. 12 x 3 cm. 15 x 3 cm. 20 x 3 cm.



TAÇ / CROWN



STC-01

18 x 8 cm.



15 x 9 cm.

STC-06



STC-02

18 x 6.5 cm.



15 x 8 cm.

STC-07

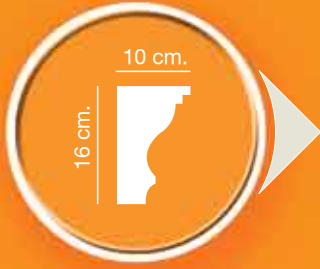

STC-03

16 x 10 cm.



14.5 x 5.5 cm.

STC-08



STC-04

15 x 11.5 cm.



12.5 x 7.5 cm.

STC-09



STC-05

15 x 11.5 cm.



12 x 7 cm.

STC-10



DESENLI TAÇ / FIGURED CROWN



15 x 11.5 cm.

D/STC-04



15 x 11.5 cm.

D/STC-05



15 x 8 cm.

D/STC-06



D/STC-01

15 x 11.5 cm.



15 x 8 cm.

D/STC-07



D/STC-02

15 x 11.5 cm.



15 x 8 cm.

D/STC-08

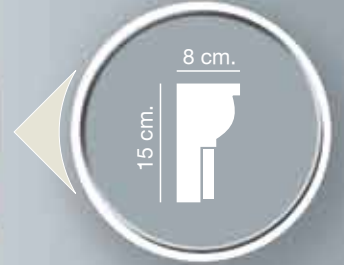

D/STC-03

15 x 11.5 cm.



15 x 8 cm.

D/STC-09



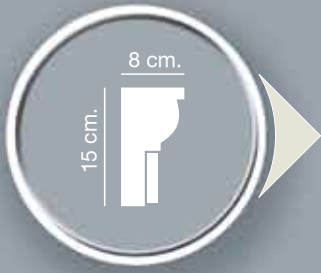

D/STC-10 15 x 8 cm.



D/STC-11 18 x 6.5 cm.



D/STC-12 18 x 6.5 cm.



D/STC-13 18 x 6.5 cm.



D/STC-14 16 x 8 cm.



D/STC-15 20 x 15 cm.

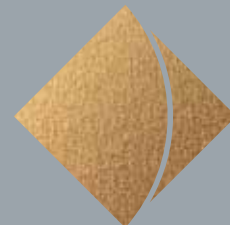

DENİZLİK / WINDOW SILLS





SDN-16 12.5 x 6 cm.



SDN-17 11.5 x 4.5 cm.



SDN-18 10.5 x 8 cm.



SDN-19 15 x 7 cm.



SDN-20 14.5 x 4.5 cm.



SDN-21 10 x 4 cm.



Yapılarınızın vazgeçilmez birleşeni.

Tasarımlarını özenle oluşturduğumuz ürün yalpozemizin yanı sıra, isteğiniz doğrultusunda gerçekleştirebildiğimiz özel tasarımlar ile de, siz değerli müşterilerimizin her zaman memnuniyetini ön planda tutmayı hedeflemekteyiz.

ÇİTA / LATH



SCD-01



SCD-01
5 x 2.5 cm.

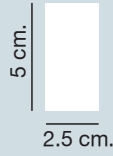

SCD-01
5 x 3.5 cm.

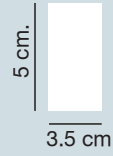

SCD-01
5 x 4.5 cm.

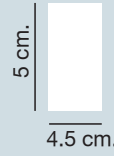

SCD-01
5 x 6 cm.



SCD-01
8 x 5 cm.

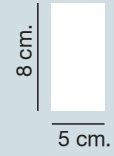

SCD-02



SCD-02
5 x 3.5 cm.



SCD-02
5 x 4.5 cm.



SCD-02
5 x 6 cm.



SCD-02
6 x 8 cm.



SCD-02
10 x 5 cm.

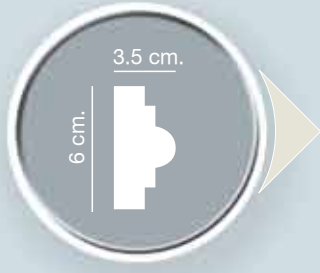

SCD-03



6 x 3.5 cm.

10 x 3 cm.

SCD-06

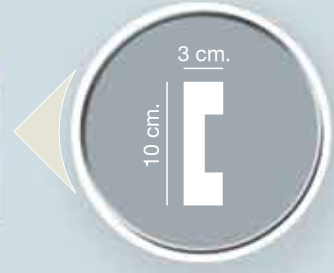

SCD-04



6.5 x 3.5 cm.

8 x 5 cm.

SCD-09



FUGAMAX

10 x 3 cm.

SFC-13



SFC-14



10 x 4 cm.

10 x 5 cm.

SFC-15



BORU KAPAMA / PIPE CLOSER

SBK-01

24 x 10 cm.

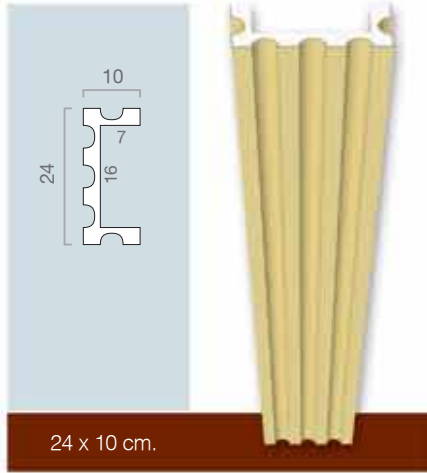

SBK-02

19 x 15.5 cm.

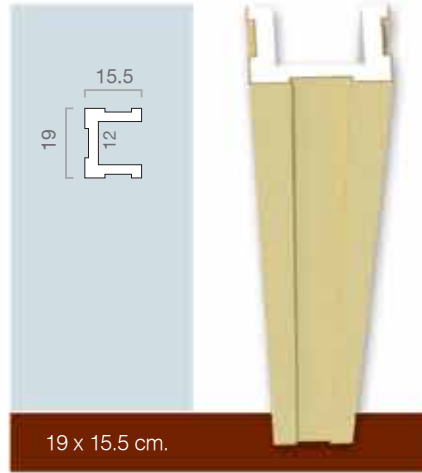

SBK-03

16 x 14 cm.

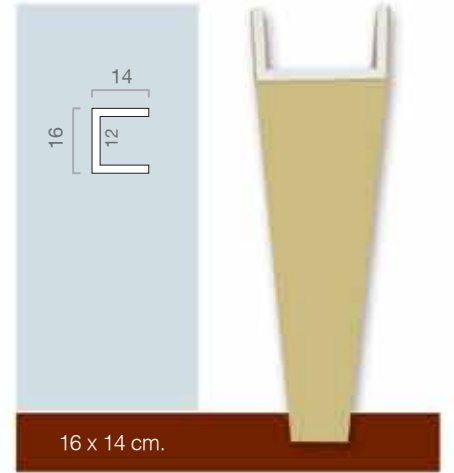

HARPUŞTA / COVER FENCE

SHP-01

21x34.5x15.5 cm.

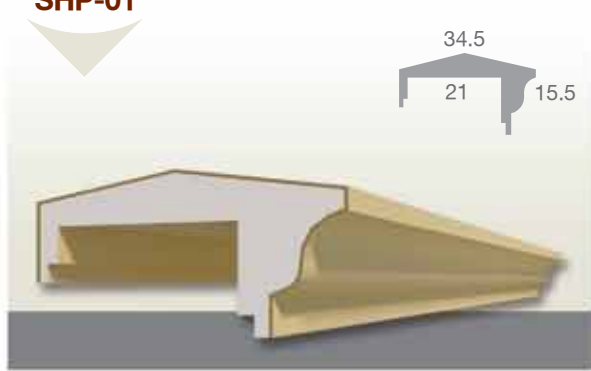

SHP-03

21x40x20 cm.

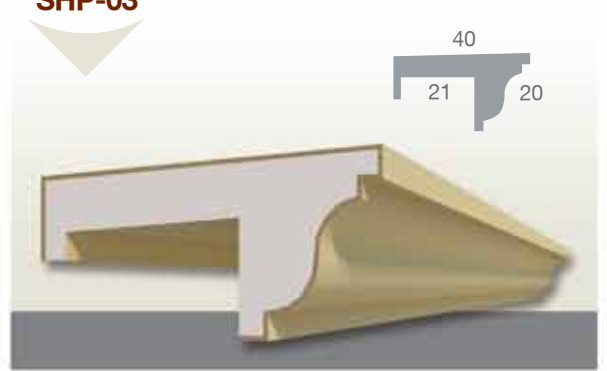

SHP-02

21x28.5x10.5 cm.

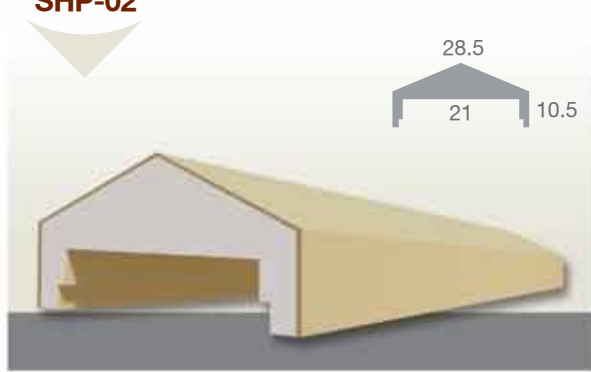

SHP-04

21x34.5x15.5 cm.

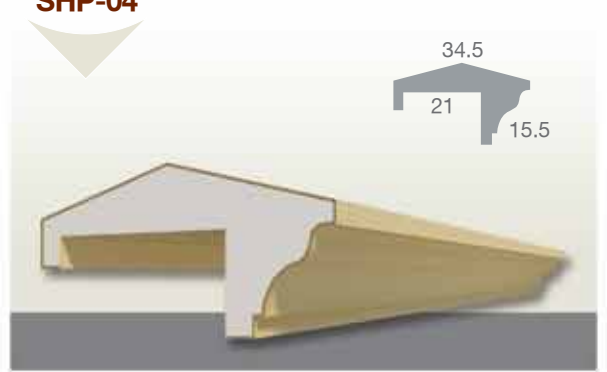

KAT SİLMESİ / FLOOR STRINGER



SKS-02 36.5 x 10 cm.



25 x 15 cm. **SKS-10**

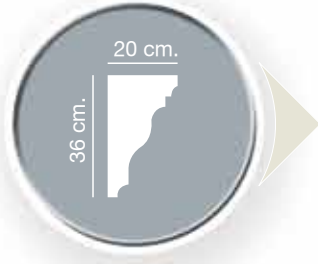

SKS-03 36 x 20 cm.



22 x 8 cm. **SKS-11**



SKS-04 35 x 25 cm.



50 x 30 cm. **SKS-13**



SKS-05 35 x 18 cm.



33 x 4 cm. **SKS-15**



SKS-06 32 x 16 cm.



27 x 9 cm. **SKS-16**



SKS-09 30 x 19 cm.



20 x 10 cm. **SKS-17**





SKS-18 19.5 x 7 cm.



SKS-19 30 x 6 cm.



SKS-20 20 x 13 cm.



SKS-21 19 x 5.5 cm.



SKS-22 17.5 x 6 cm.

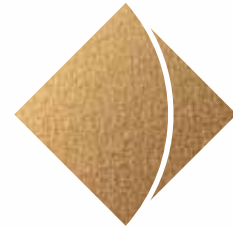

DESENLI KAT SİLMESİ / FIGURED FLOOR STRINGER



D/SKS-01

35 x 20 cm.



30 x 6 cm.

D/SKS-07



D/SKS-02

32 x 16 cm.



30 x 6 cm.

D/SKS-08



D/SKS-03

30 x 19 cm.



30 x 6 cm.

D/SKS-09



D/SKS-04

22 x 8 cm.



30 x 6 cm.

D/SKS-10



D/SKS-05

22 x 8 cm.



20 x 5 cm.

D/SKS-11



D/SKS-06

22 x 8 cm.



20 x 5 cm.

D/SKS-12





D/SKS-13 20 x 5 cm.



26 x 15 cm. **D/SKS-17**



D/SKS-14 20 x 5 cm.



35 x 19 cm. **D/SKS-18**



D/SKS-15 20 x 6.5 cm.



30 x 15 cm. **D/SKS-19**



D/SKS-16 50 x 12 cm.



Yapılarınızı Taçlandırın

Tasarımlarını özenle oluşturduğumuz ürünlerimiz yapılarınıza ayrıcalık kazandırır. STROPOL ile görsel bütünlüğü bir adım daha ileriye taşıyın.



KÖŞE ELAMANI / CORNER ELEMENTS

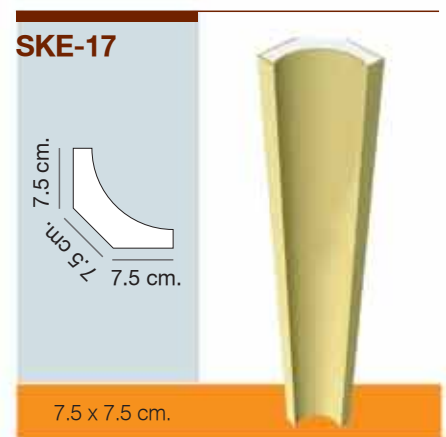
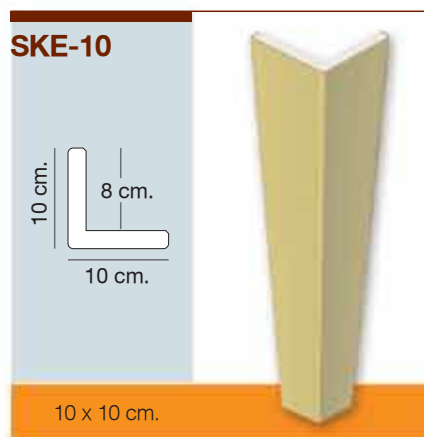
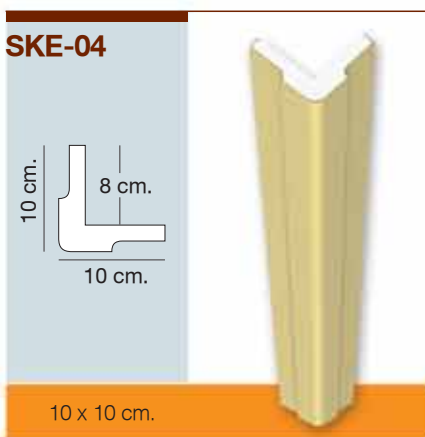
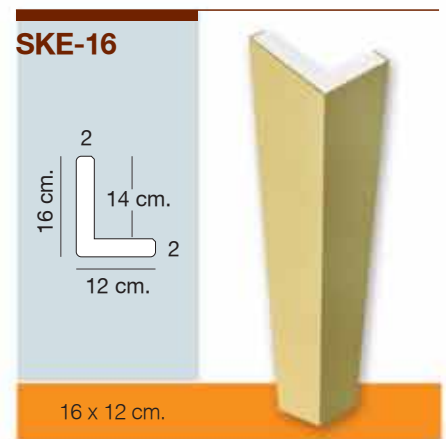
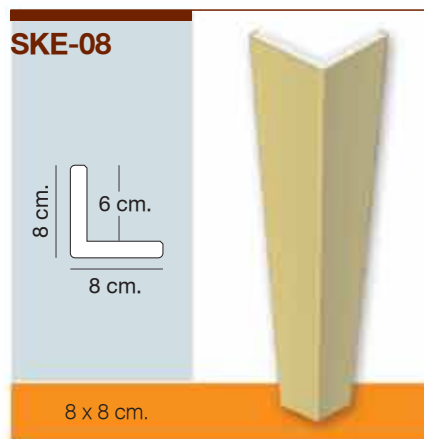
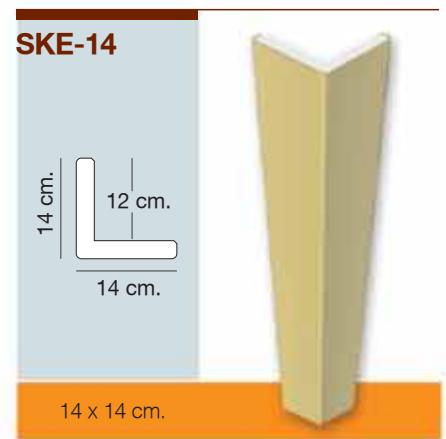
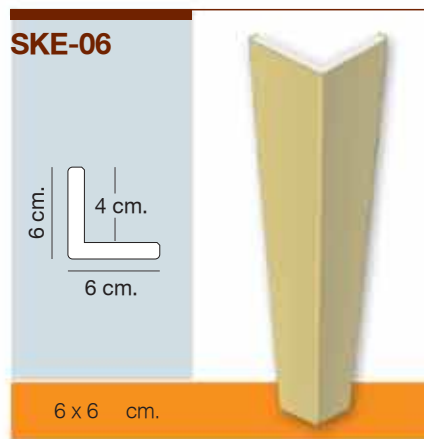
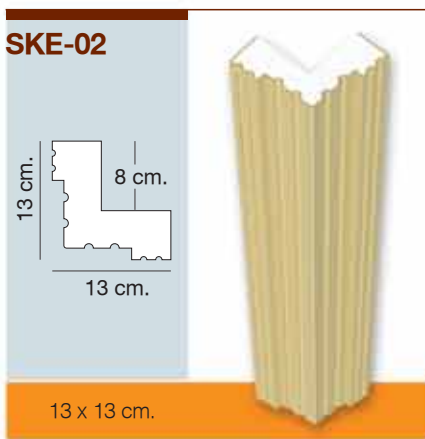
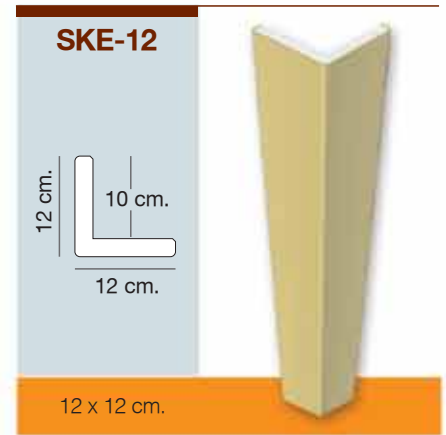
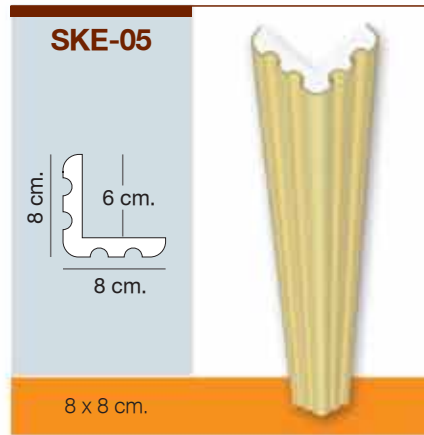

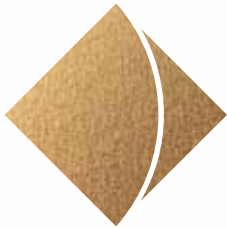
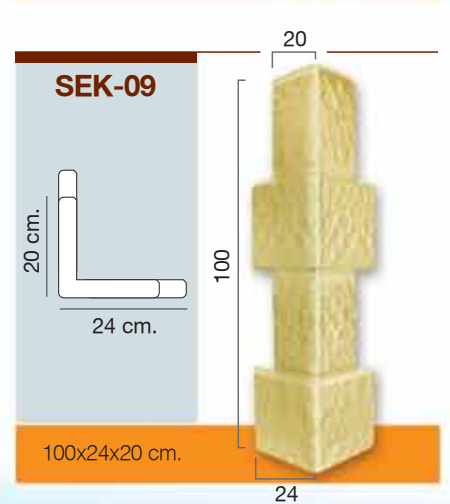
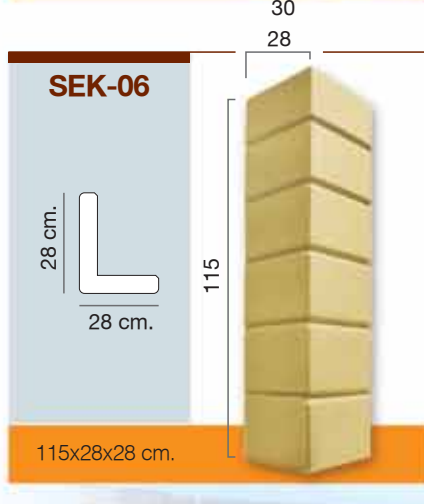
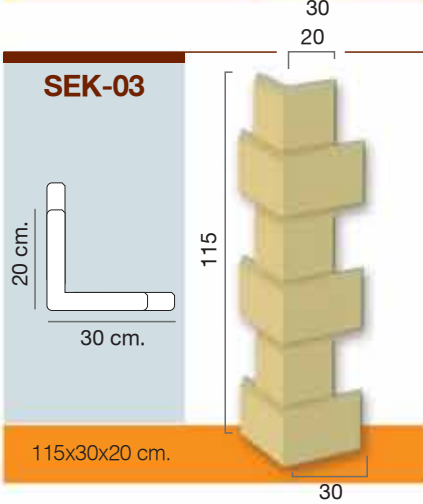
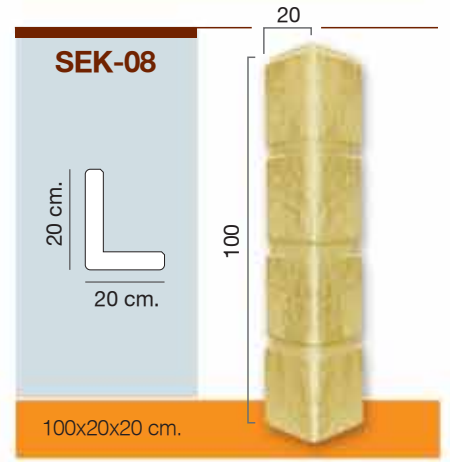
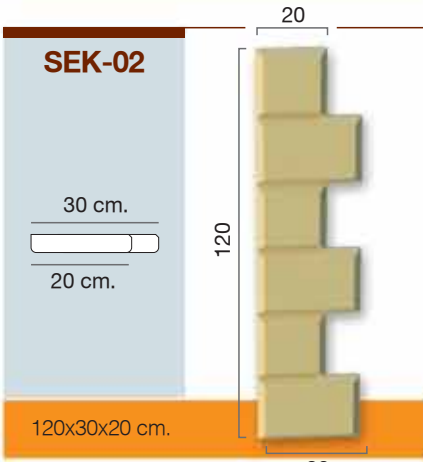
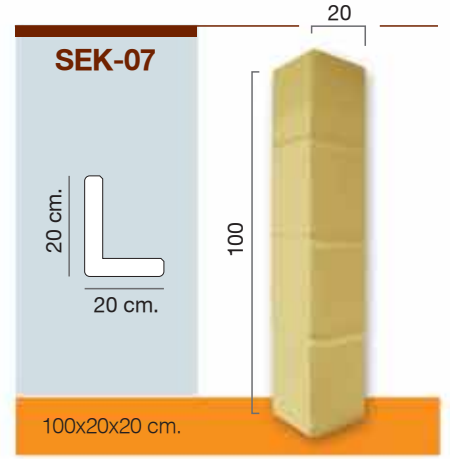
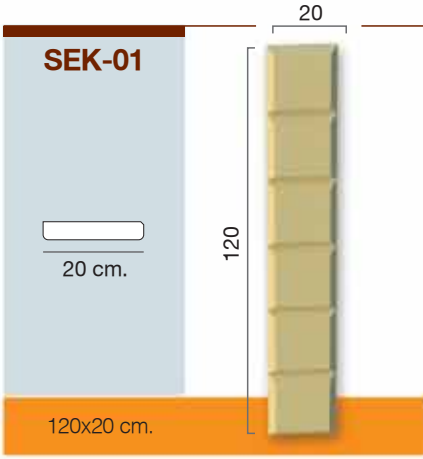

Tasarımlarını özenle oluşturduğumuz ürünlerimiz yapılarınıza ayrıcalık kazandırır. STROPOL ile görsel bütünlüğü bir adım daha ileriye taşıyın.



ENJEKSİYON DESENLİ KAPLAMALAR / INJECTION DECORATIF COATING

SEF-01

4x50x120 cm.



SEF-05

4x50x120 cm.

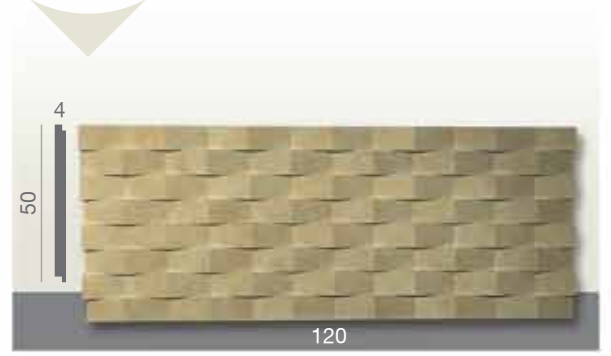

SEF-02

3.5x50x120 cm.



SEF-06

4.5x58x135 cm.



SEF-03

3.5x50x120 cm.



SEF-07

4.5x58x135 cm.



SEF-04

3.5x50x120 cm.



SEF-08

3x60x120 cm.

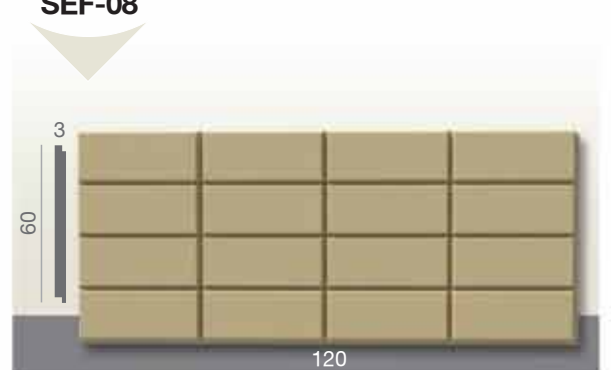

SEF-09

120x60 cm.



SEF-13

120x50 cm.

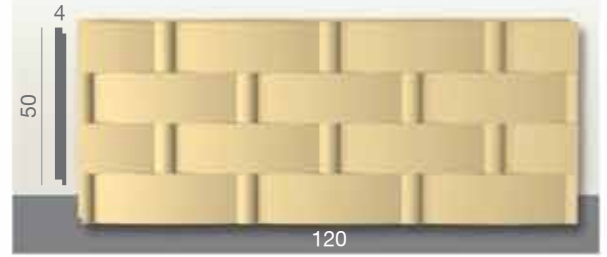

SEF-10

120x60 cm.



SEF-14

130x50 cm.



SEF-11

120x60 cm.



SEF-15

130x50 cm.



SEF-12

120x60 cm.



SEF-16

130x50 cm.

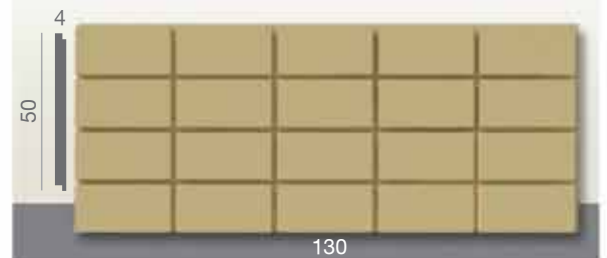

FUGA / FUGA COATING

SFG-04

50x3 cm.

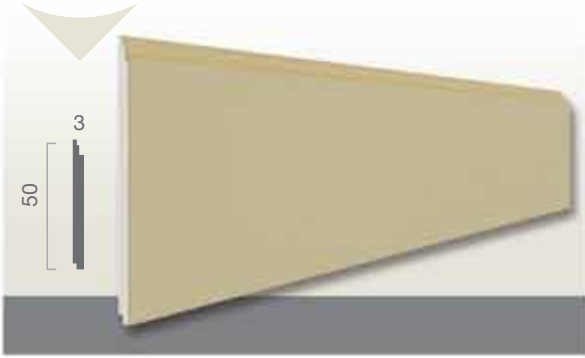

SFG-08

50x3 cm.



SFG-05

50x3 cm.

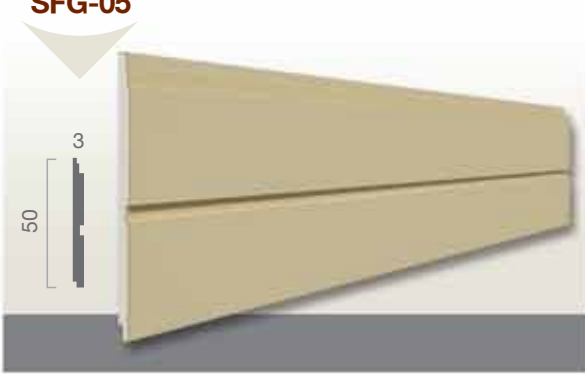

SFG-09

50x4 cm.



SFG-06

50x4 cm.



SFG-10

50x4 cm.



SFG-07

50x3 cm.



SFG-11

50x4 cm.



SFG-12

50x4 cm.

**SFG-13**

50x4 cm.

**SFG-14**

50x4 cm.

**SFG-15**

50x3 cm.

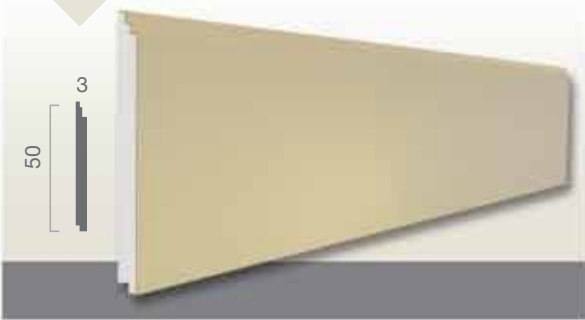
**SFG-16**

50x4 cm.



Yapılarınızı Taçlandırın

Ürün çeşitliliği ve kalite üstünlüğü ile yapılarınızın vazgeçilmez birleşeni Cephe Kaplama gurubunda aradığınız her detayı bulabilirsiniz.

TAŞ DESEN / STONE COATING

STD-01

50x3 cm.



STD-04

50x3 cm.



STD-05

50x3 cm.



STD-08

50x3 cm.



YALI BASKI / SHORE SIDING

SYB-05

50x3.5 cm.



SYB-06

50x3.5 cm.



SYB-07

50x3.5 cm.

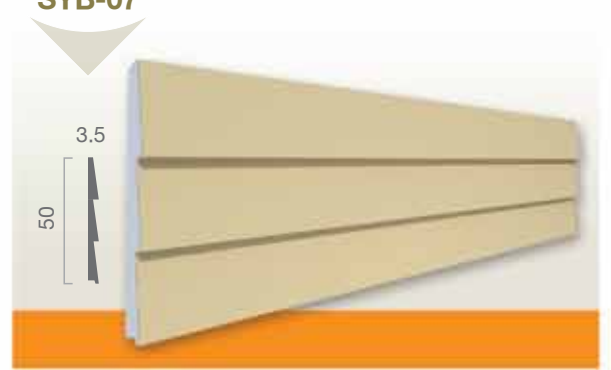

TUĞLA GÖRÜNÜMÜ / BRICK FIGURED COATING

STG-01

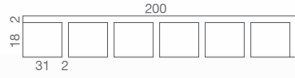

20x3.5 cm.

STG-04



50x4 cm.

STG-02

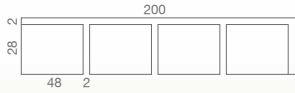

30x3.5 cm.

STG-05

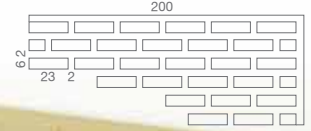

50x4 cm.

STG-03

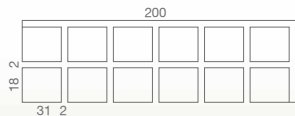

40x3.5 cm.



Tasarımlarını özenle oluşturduğumuz ürünlerimiz yapılarınıza ayrıcalık kazandırır. STROPOL ile görsel bütünlüğü bir adım daha ileriye taşıyın.



AHŞAP DESEN / WOODEN COATING

SAD-03

50x3 cm.



SAD-05

50x3 cm.



SAD-04

50x3 cm.



SAD-07

50x3 cm.



SAD-08

50x3 cm.



ÇİZGİLİ / STRIPED COATING

SCF-03

50x3 cm.



SCF-04

50x3 cm.



SCF-05

50x3 cm.



Yapılarda, Dış Cephelerin Kişiliğini Değiştiriyoruz

Tasarımlarınızda, yaratıcılığınızı bir üst seviyeye taşıyacağına inandığımız ürün yelpazemiz, uygulamalarınızda sınırsız dekoratif kombinasyonlar kurma imkanı sağlayacaktır.

PENCERE ÜSTÜ / WINDOW DECOR-TOP

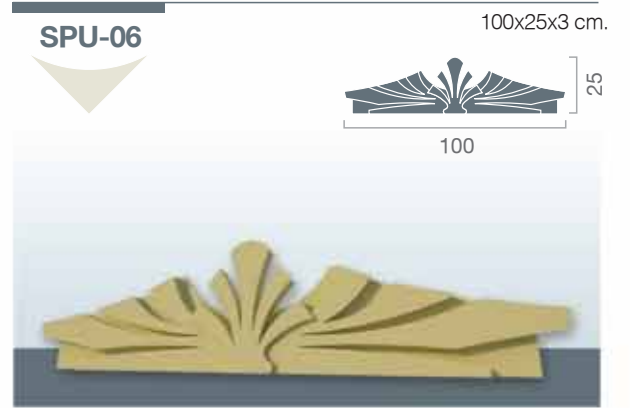
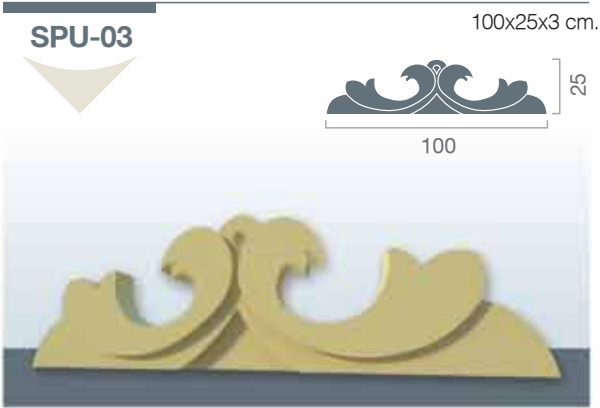
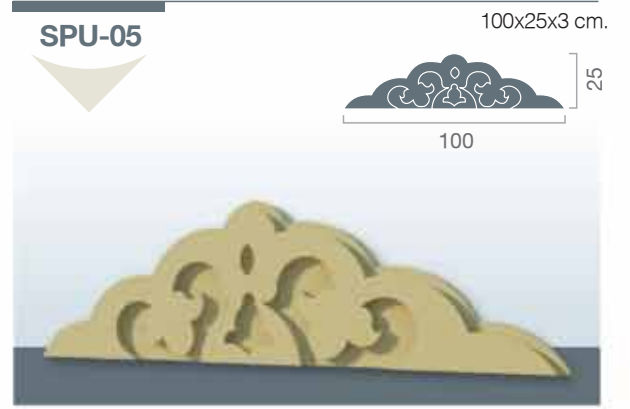
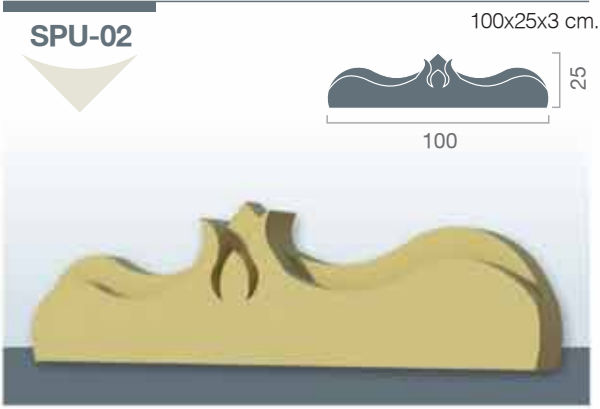
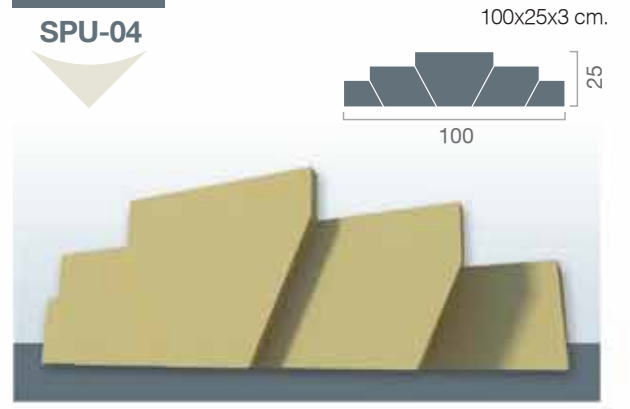
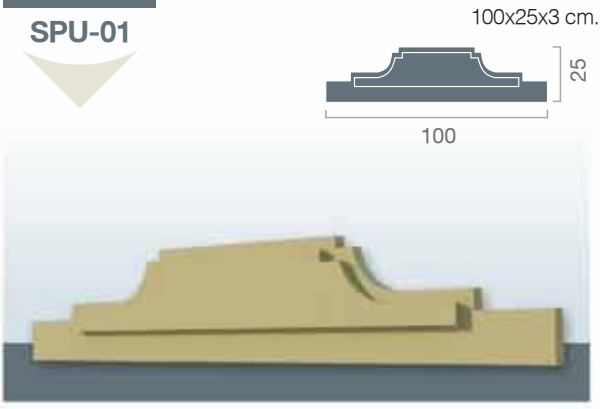

Yapılarda, Dış Cephelerin Kişiliğini Değiştiriyoruz



MOTIF / MOTIF

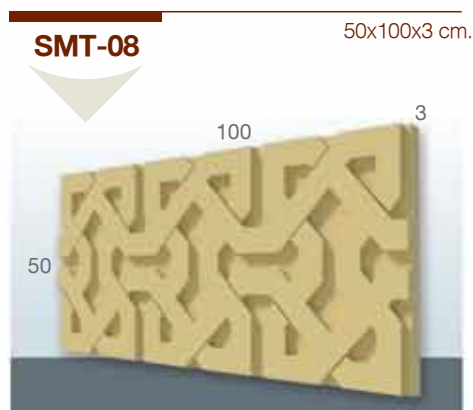
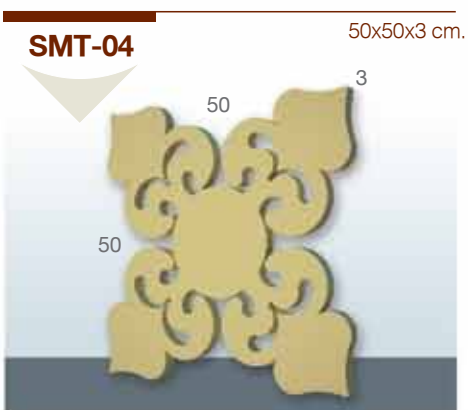
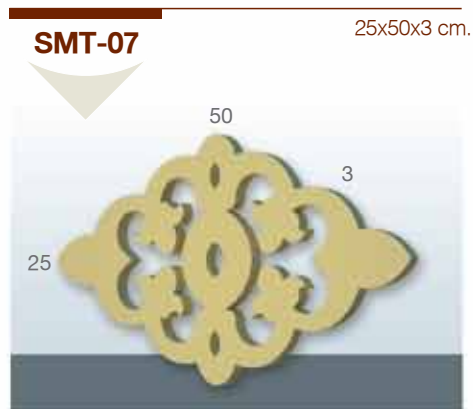
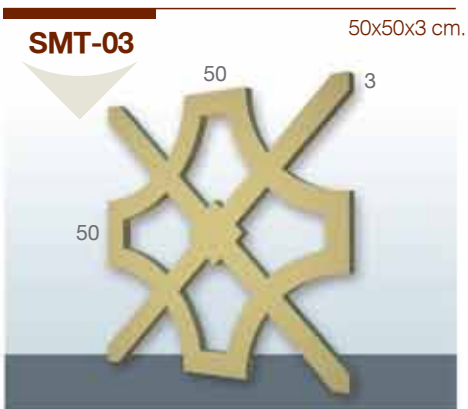
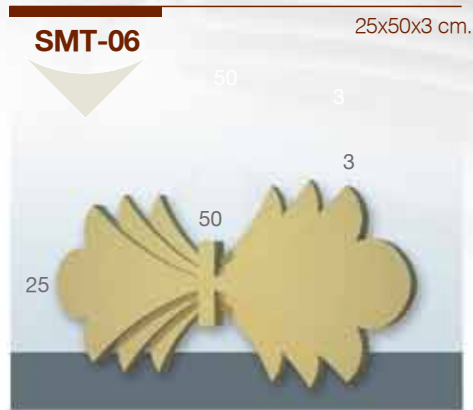
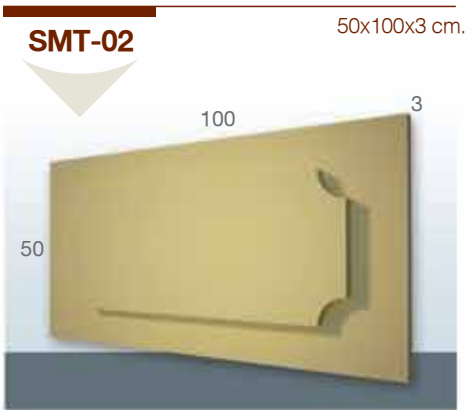
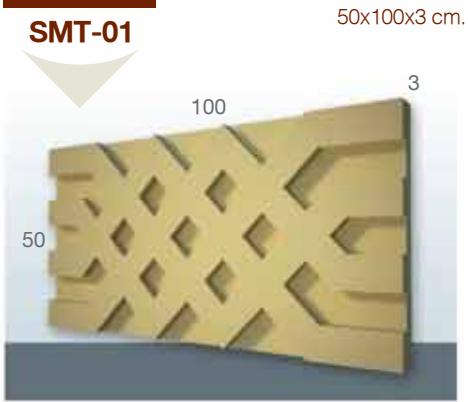

ALT DEKOR / WINDOW DECOR-UNDER

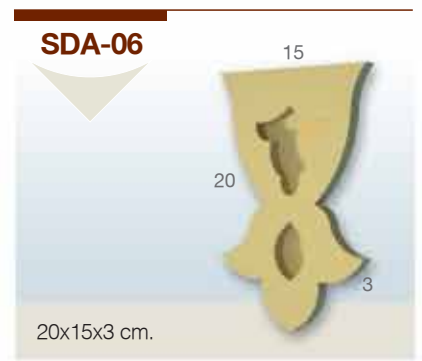
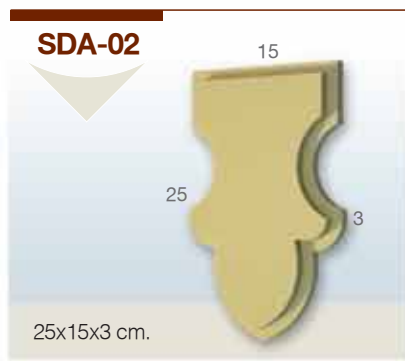

YAN DEKOR / WINDOW DECOR-SIDE

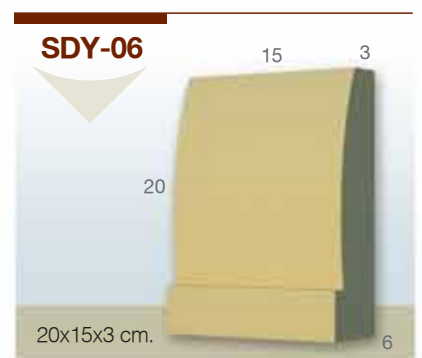

KİLİT TAŞI / KEYSTONE



PAYANDA / BUTTRESS

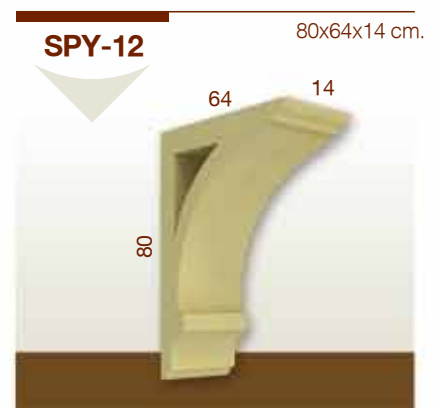



Siz hayal edin, biz gerçekleştirelim.

YUVARLAK SÜTÜN / PILLAR

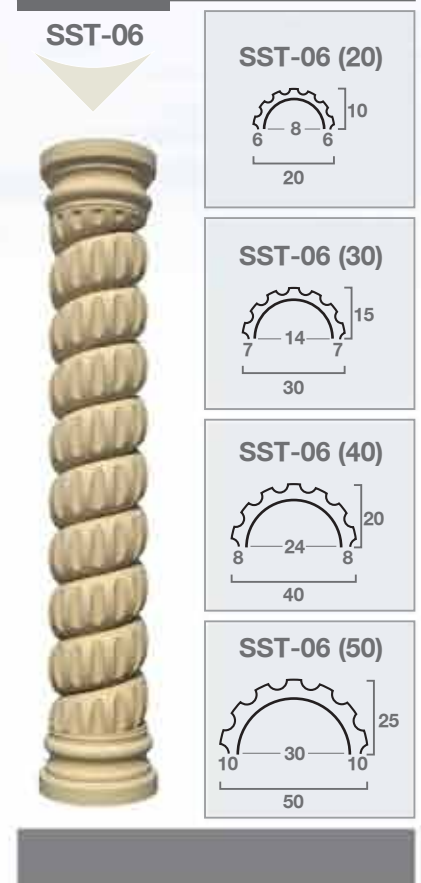
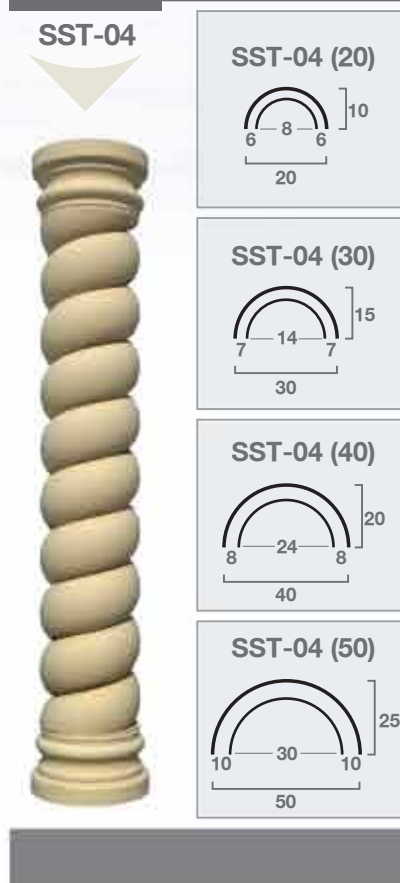
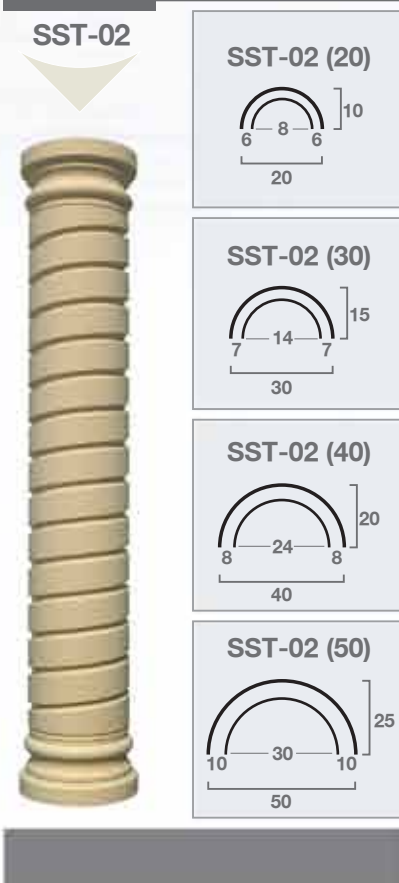
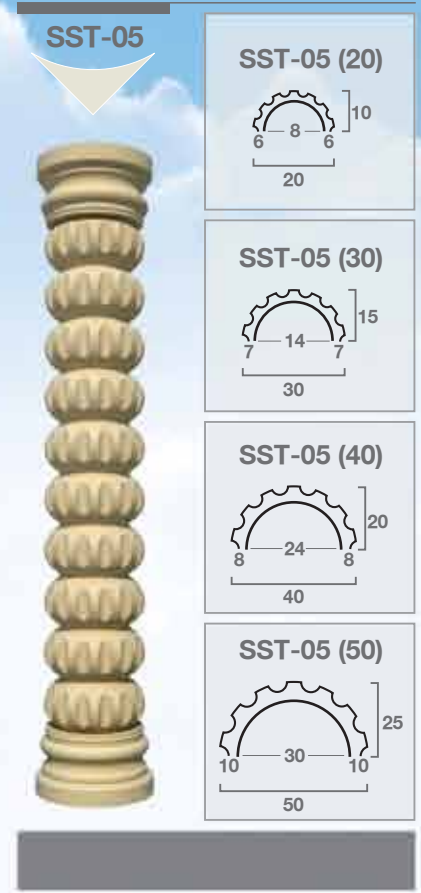
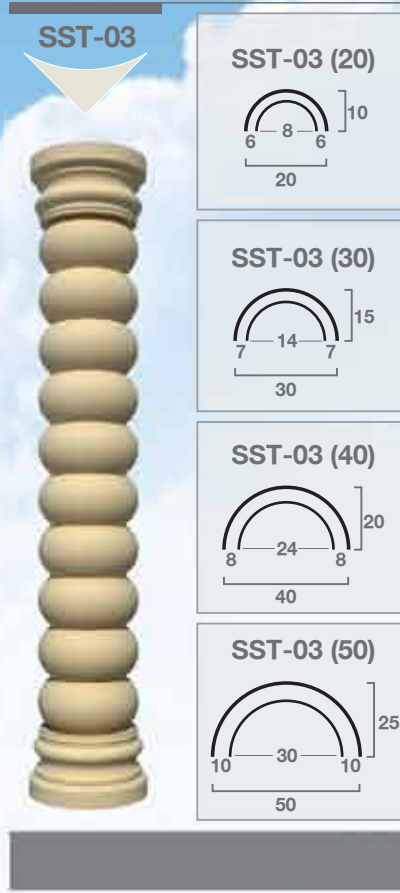
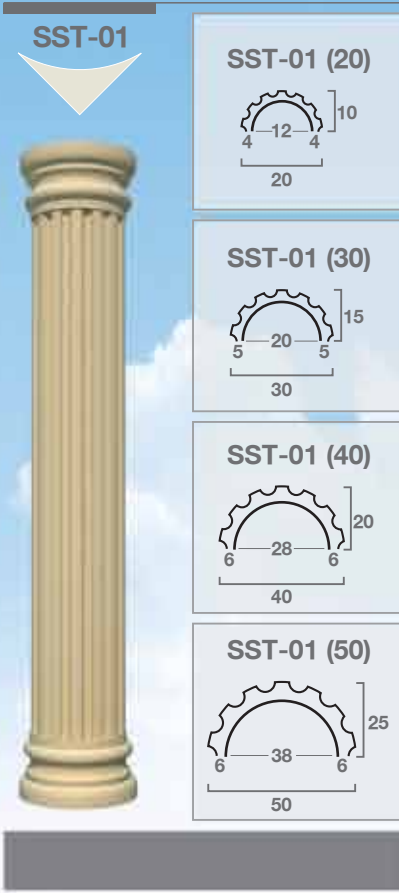

DÜZ SÜTÜN / PILLAR

SST-07

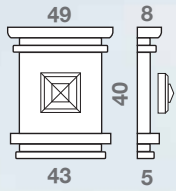
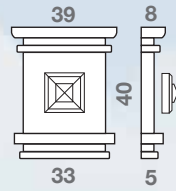
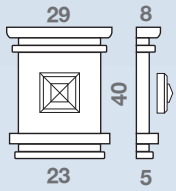
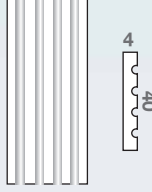
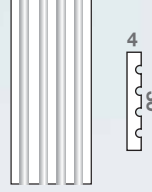
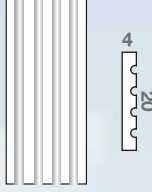
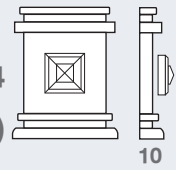
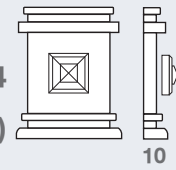
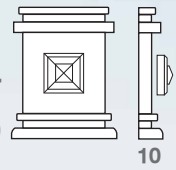
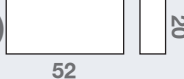
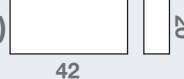
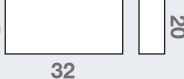

SST-07 (40)	SST-07 (30)	SST-07 (20)
		
<p>Ö SSV-01 40x4 cm</p> 	<p>SSV-01</p> 	<p>SSV-03</p> 
<p>SKT-04 SKD-40(40)</p> 	<p>SKT-04 SKD-40(30)</p> 	<p>SKT-04 SKD-40(20)</p> 
<p>SSB-20(40)</p> 	<p>SSB-20(30)</p> 	<p>SSB-20(20)</p> 

SÜTÜN KAİDE / PEDESTAL

SSK-01

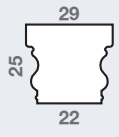
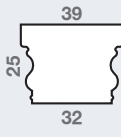
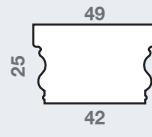
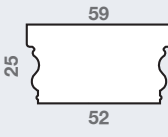

SSK-01 (20)	SSK-01 (30)	SSK-01 (40)	SSK-01 (50)
			



SKD-40

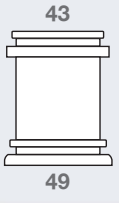
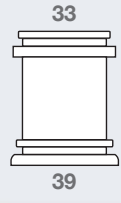
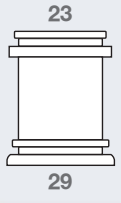

SKD-40 (40)	SKD-40 (30)	SKD-40 (20)
		

SSB-20



SSB-20 (20)	
SSB-20 (30)	
SSB-20 (40)	

PENCERE MODELLERİ / WINDOW SAMPLES

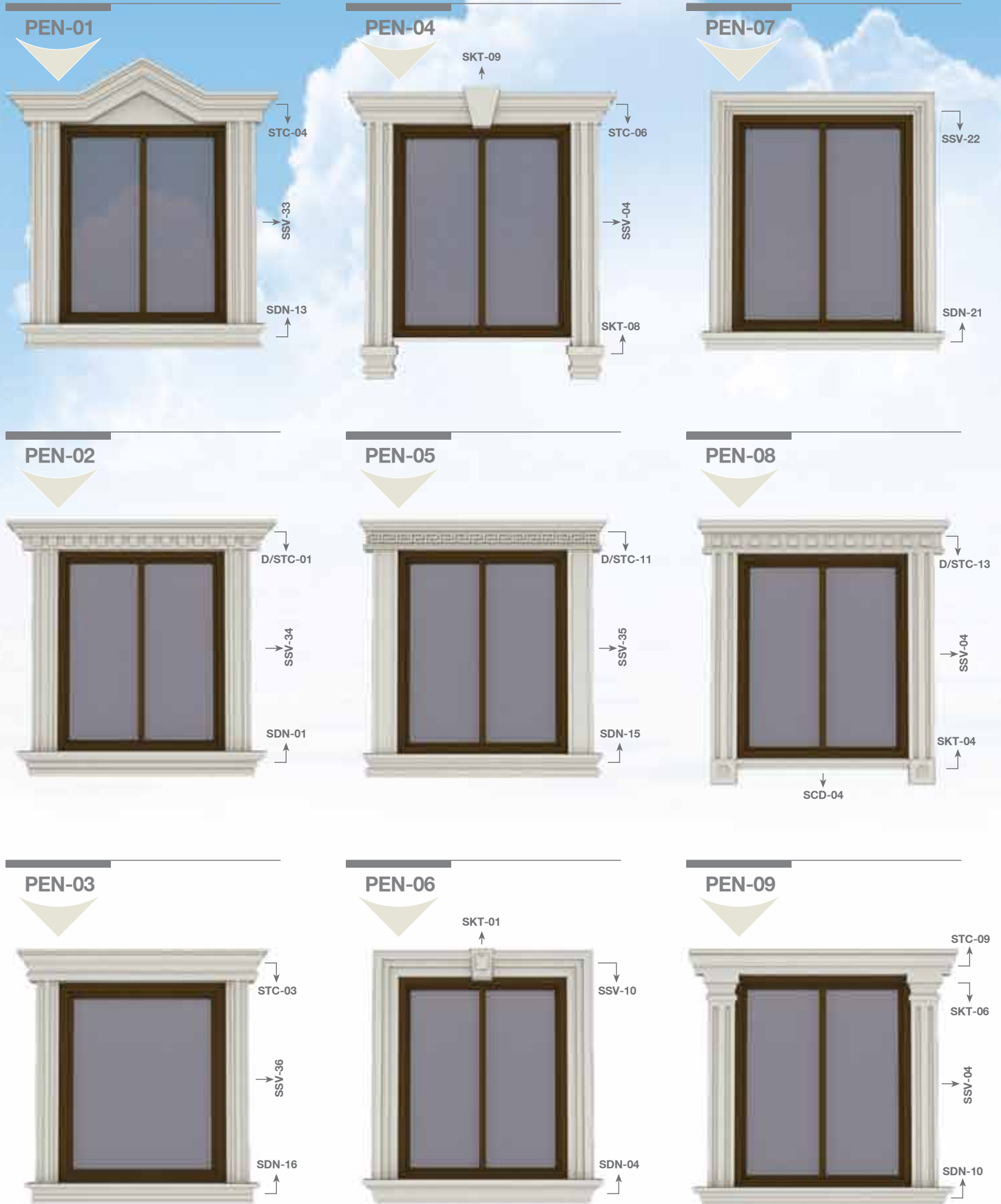

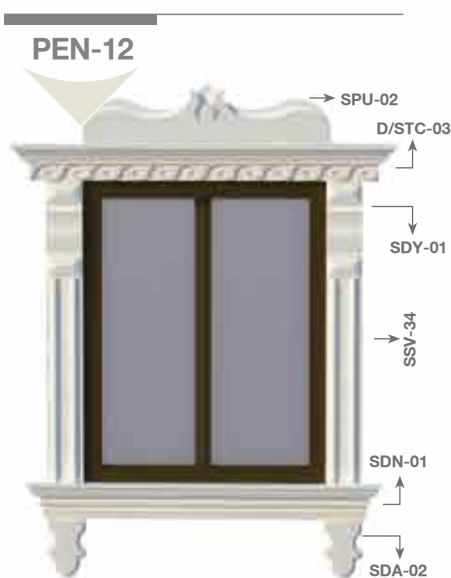
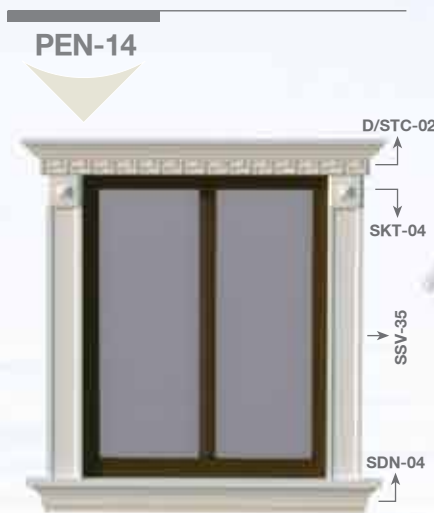



**STROPOL
YAPI MALZEMELERİ DEKORASYON
SANAYİ ve TİCARET LTD. ŞTİ.**

Aslanbaş İş Merkezi Havutlu Mah.
Karataş Bul. No: 511 01375 Yüreğir - ADANA
Tel: 0 322 233 22 60 Fax: 0 322 234 22 60
e-mail: stropol@stropol.com.tr
www.stropol.com.tr

